

POSITION	FÄRG
K14	LILA / ORANGE
K15	GUL / SVART
K1	LILA
K2	ORANGE
K3	GRÅ / SVART

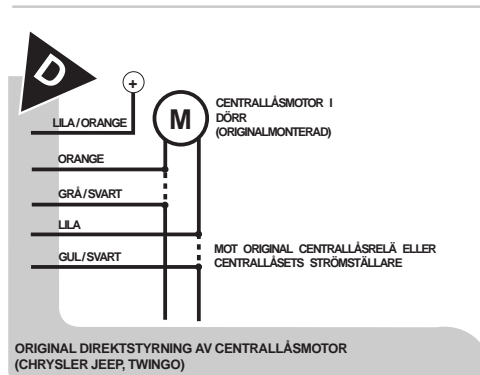

POSITION	FÄRG
K14	LILA / ORANGE
K15	GUL / SVART
K1	LILA
K2	ORANGE
K3	GRÅ / SVART

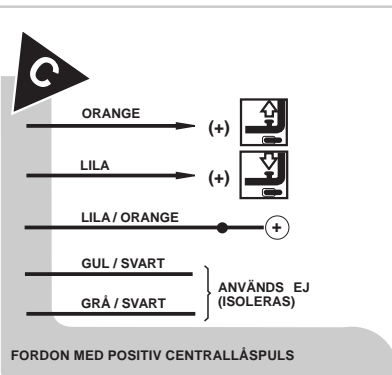

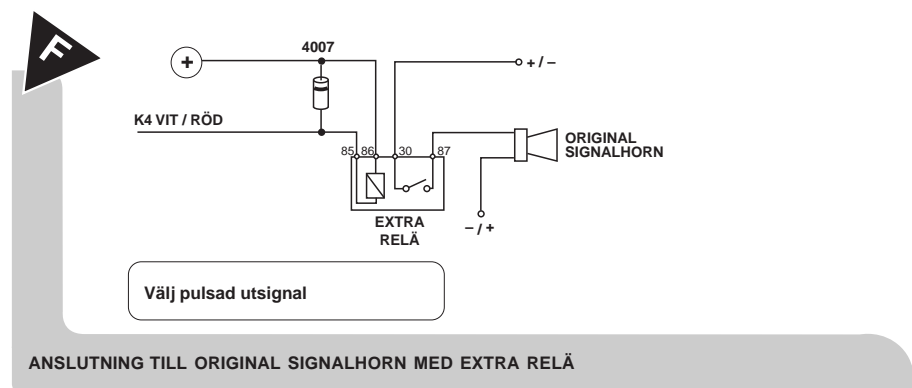
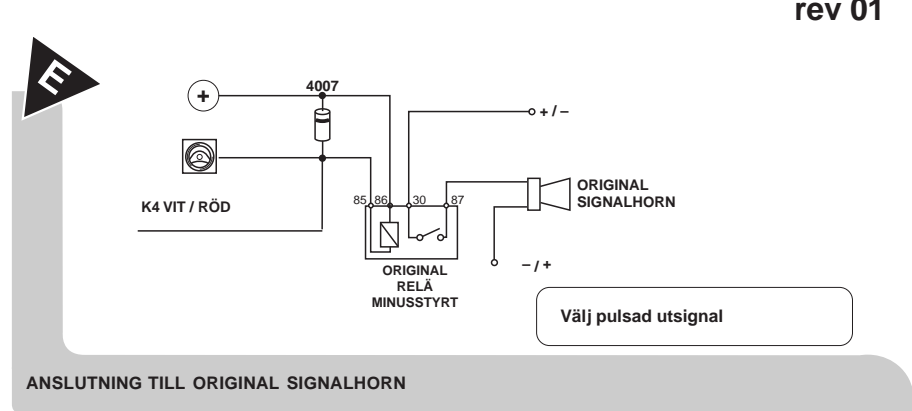

**G**

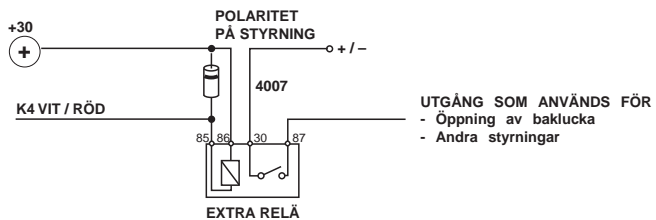

Använd knapp B

RADIOSTYRD EXTRA UTGÅNG (KNAPP B)

**H**

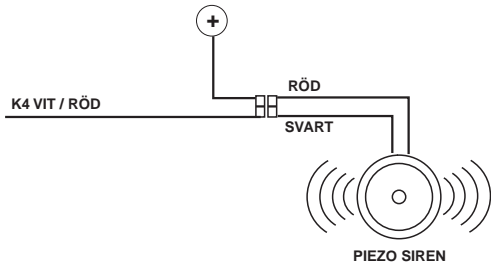

Välj kontinuerlig utsignal

ANSLUTNING AV EXTRA SIREN (MAX 0,5A)

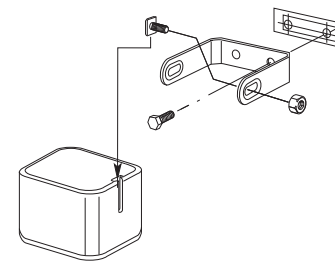
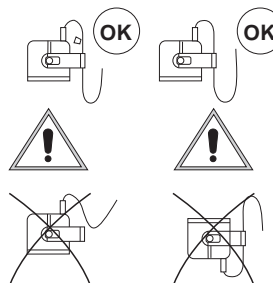

ANSLUTNING AV NIVÅSENSOR OCH MIKROVÅGSENSOR

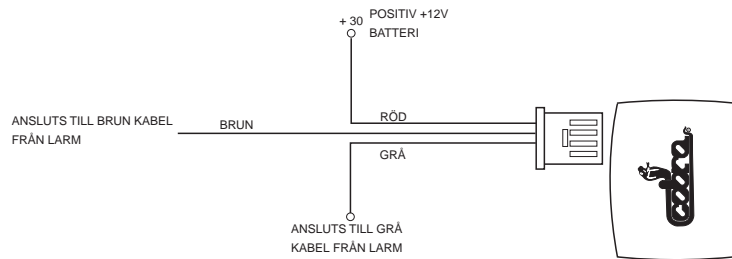

MONTERING AV MIKROVÅGSENSOR

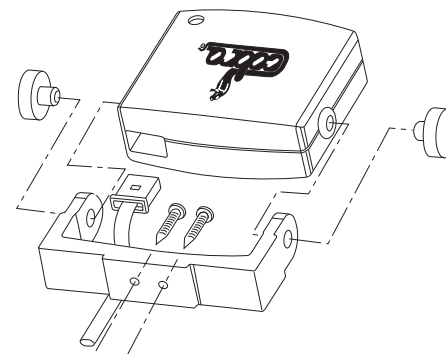

## MONTERING AV TÄCKKÅPA

Graden av vattentätighet för denna enhet garanteras av packningar och kåpor. Skjut in kontakten och fäst täckkåpan med de 4 svarta skruvarna som medföljer satsen.

### 1 ANSLUTNING AV KABLAGE

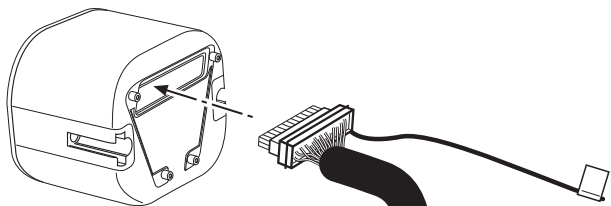

### 2 BÖJNING AV KABLAGE OCH MONTERING AV TÄCKKÅPA

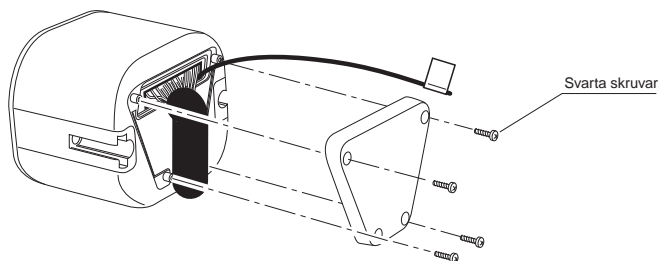

### 3 TÄCKKÅPAN MONTERAD

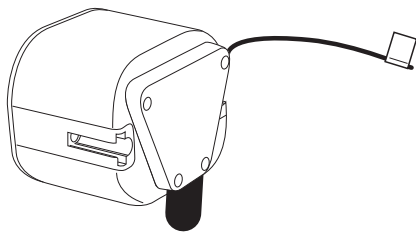

Observera kablage och antennens position enligt ovanstående bilder.

rev 01

## LARM UTAN SENSOR

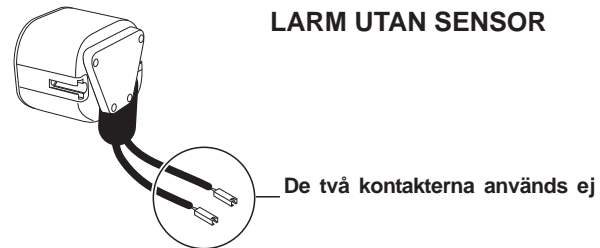

## ANSLUTNING AV ULTRALJUDSENSORER

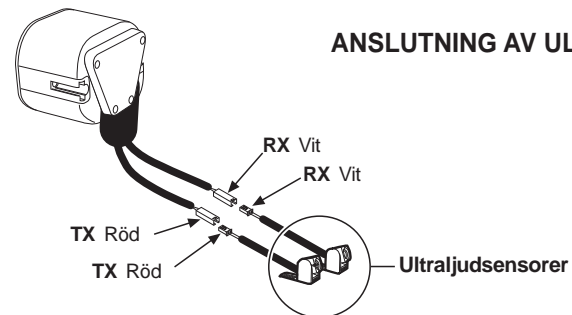

## ANSLUTNING AV GLASKROSSENSOR

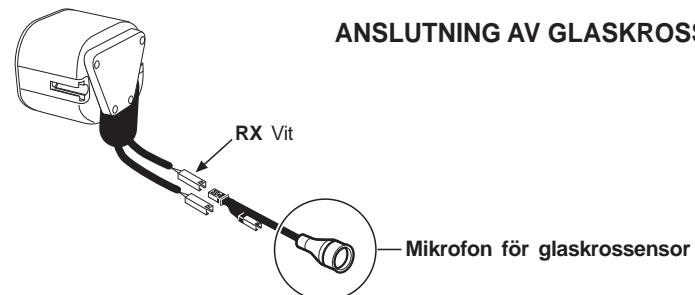

## ANSLUTNING AV ULTRALJUDSENSORER + ANSLUTNING AV GLASKROSSENSOR

